

Longitudinal datum is forward  
face of rear chassis cross-member

Side Panel Geometry

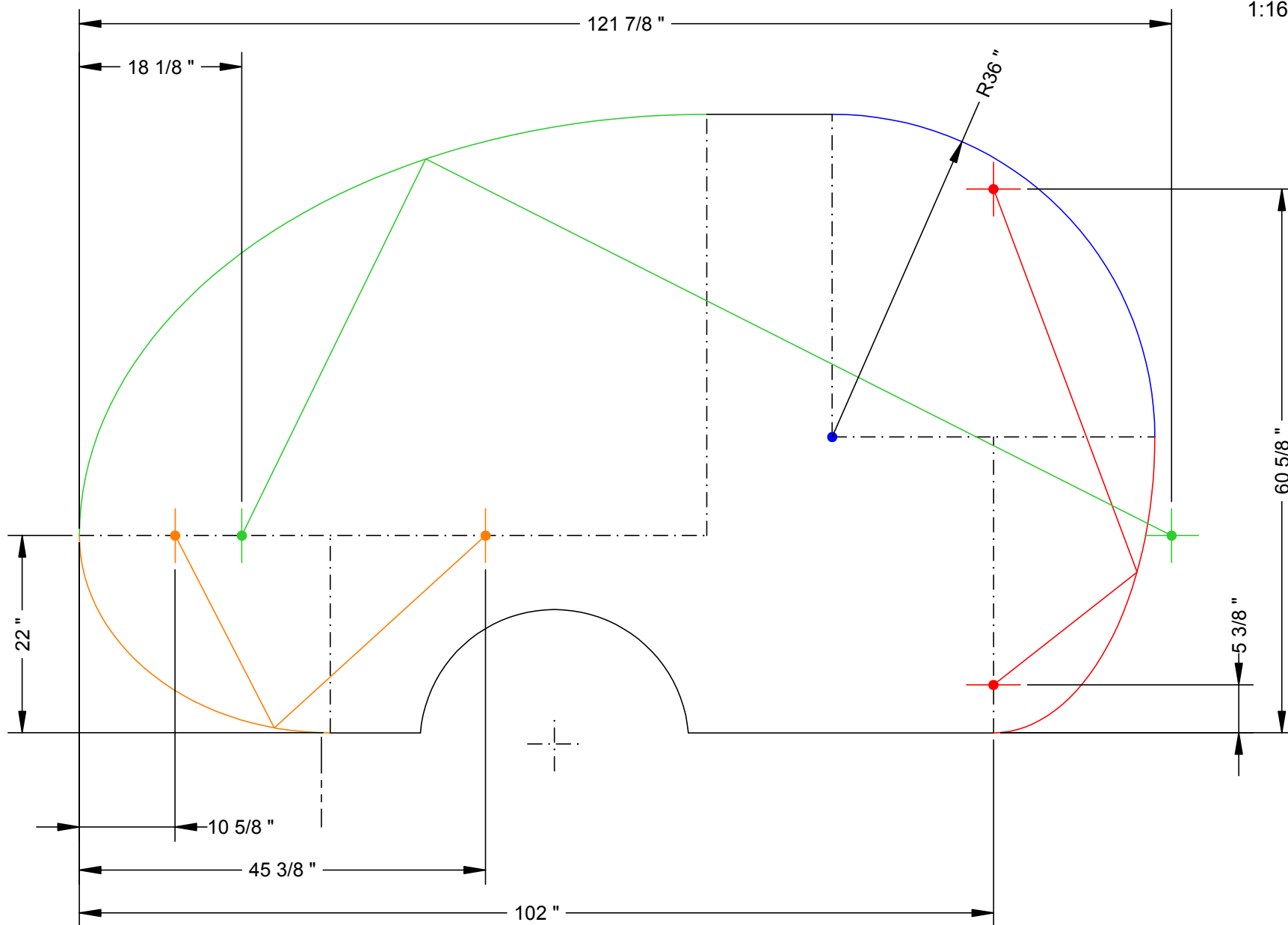

Side Panel Geometry

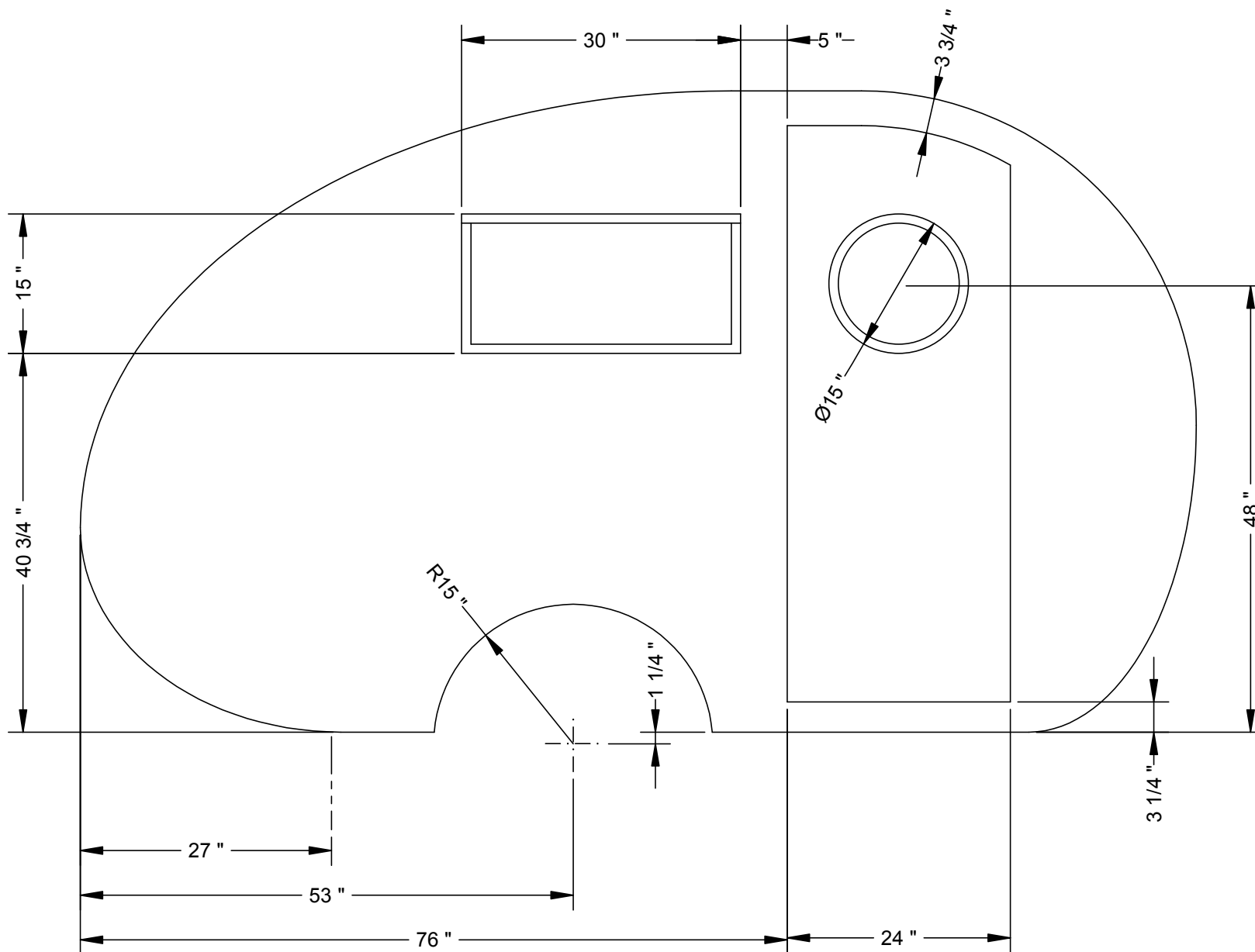

Longitudinal datum is forward  
face of rear chassis cross-member

Side Panel Geometry

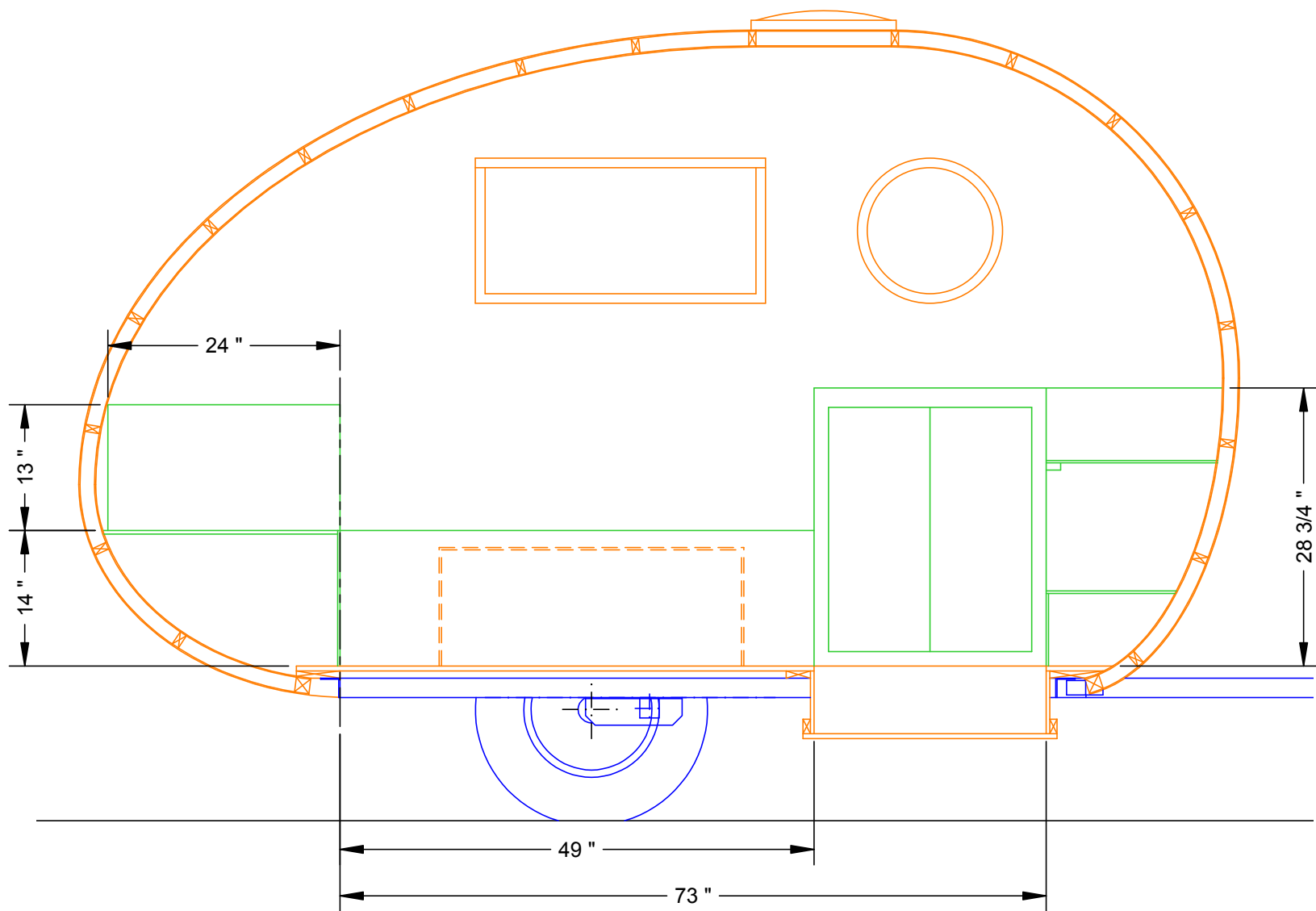

Longitudinal datum is forward  
face of rear chassis cross-member  
= front face of bunk bulkhead

Internal Geometry

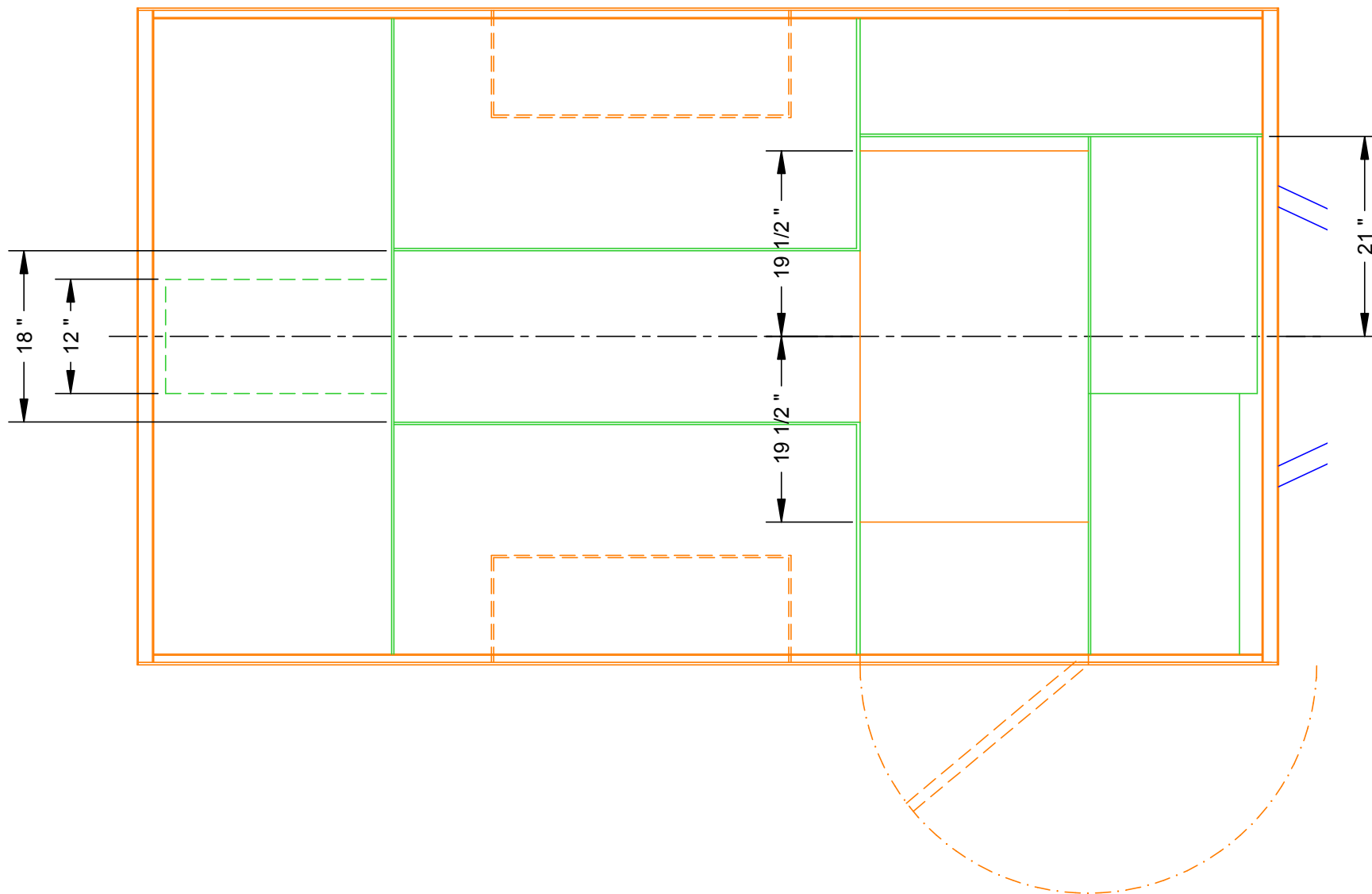

Internal Geometry - Plan View under Bunk Tops

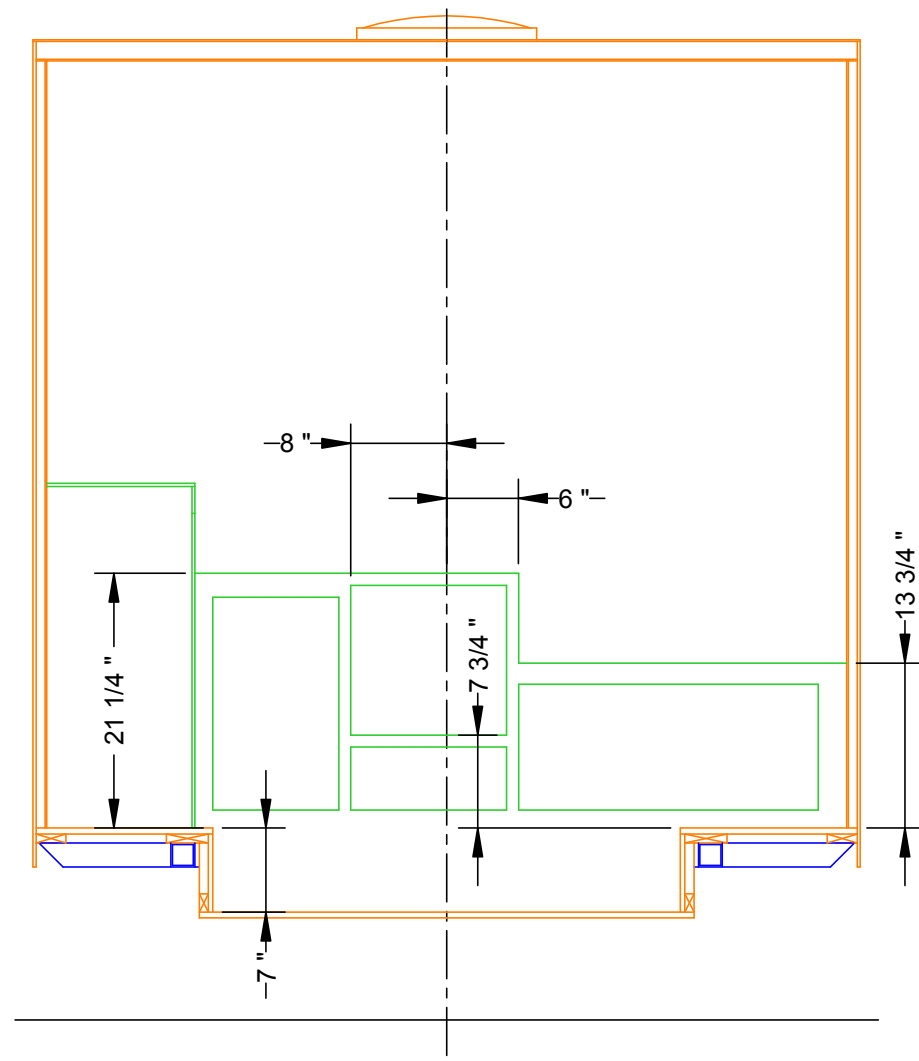
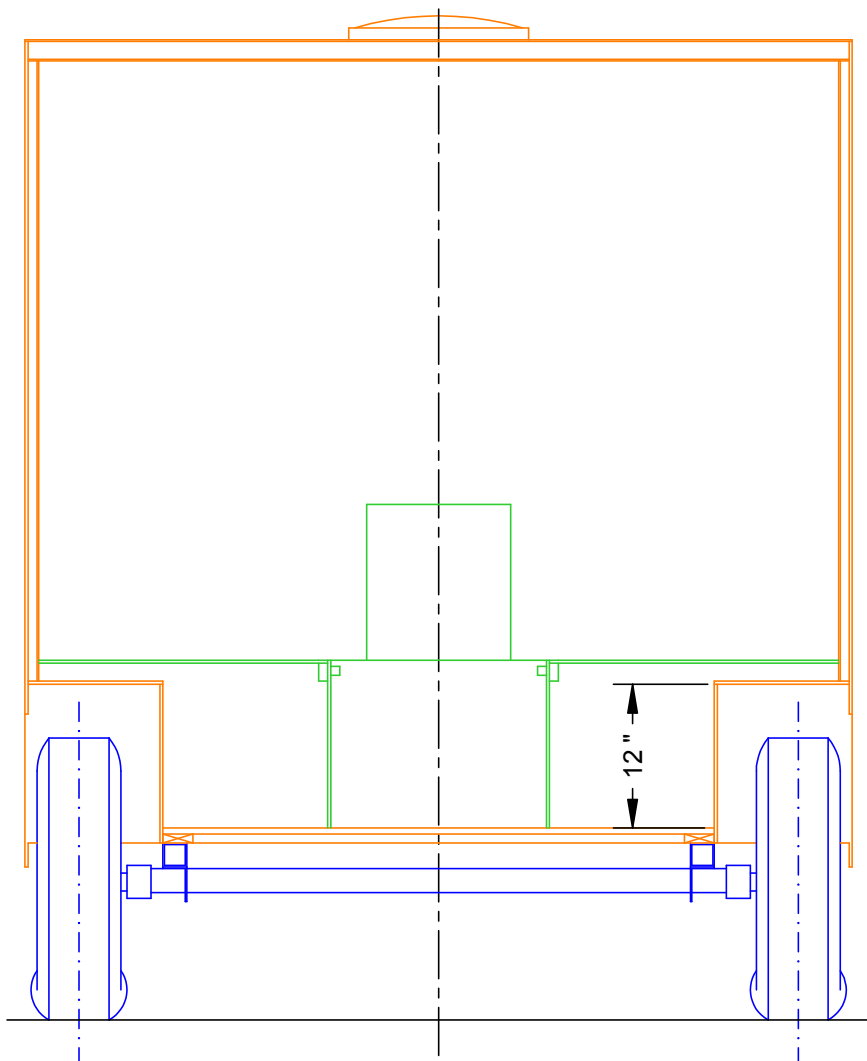

Internal Geometry

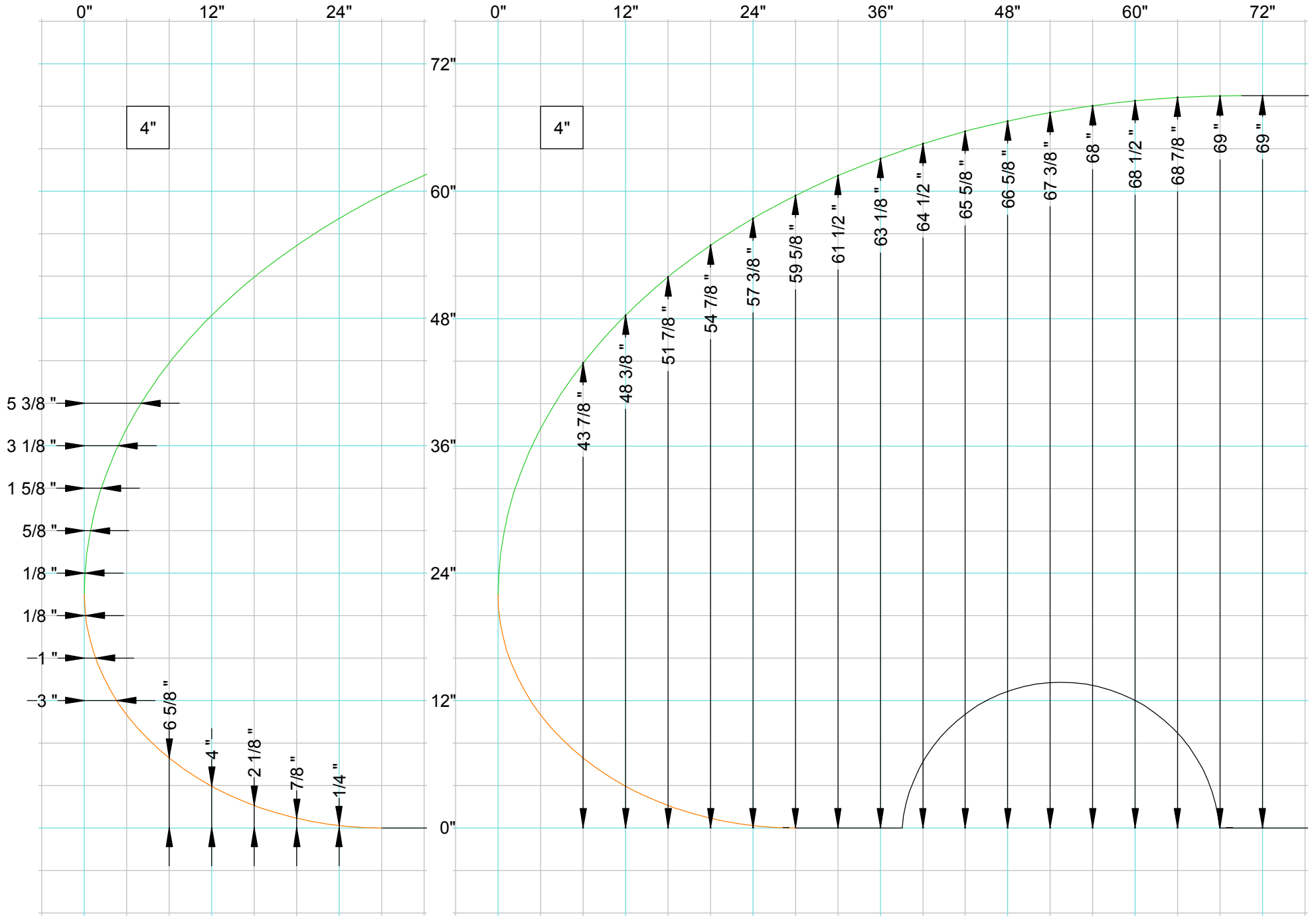

WIDGET 6 Geometry 8 1:12

